

THE WORLD PUZZLE NEWSLETTER 13



Official publication of the World Puzzle Federation



**The 16th WPC in Brazil 2007 • Activities of the German
Puzzle Federation • Puzzles from the 16th WPC
The third WSC in India • Portrait of the Champion • Cancelling
the WPC • Report on the 9th General Assembly of the WPF
Results of the 16th WPC and the 3rd WSC • WPF members**



CONTENTS

- 3 Editorial
- 4 The 16th WPC in Brazil 2007
by Diana Baptista
- 6 Activities of the German
Puzzle Federation by
Johannes Susen
- 8 Puzzles from the 16th WPC
- 12 Portrait of the Champion by
Gyorgy Istvan
- 14 Cancelling the WPC by Peter
Ritmeester
- 16 Report on the 9th General
Assembly of the WPF by
Will Shortz
- 18 WPC 2007 team pictures
- 21 WPC 2007 team results
- 22 WPC 2007 individual results
- 24 WSC 2008 team and
individual results
- 26 Statutes and Regulations
- 27 WPF members
- 30 Solutions

Address:
Kruislaan 419
1098 VA
Amsterdam
The Netherlands
Tel/Fax:
+31.20.8884643
E-mail: office@worldpuzzle.org
Internet:
www.worldpuzzle.org

The WORLD PUZZLE NEWSLETTER
Official publication of the World Puzzle
Federation

Editor
Valter Kvalić

Design
Dean Čakić

Copy Editor
Nancy Schuster

WPF Logo Design
Michael Douma

**Newsletter design based on the
model set by** Ivo Van Ijzendoorn

Printing
Labinska Tiskara - Croatia

WORLD PUZZLE FEDERATION

World Puzzle Federation

The World Puzzle Federation is an association of legal bodies with an interest in puzzles. Only one member per country can belong to the WPF. The WPF follows the Olympic standard in what constitutes a country. Information of present members and criteria for membership can be found in the members section on pages 26 - 29 of this issue.

Chairman: Vitezslav Koudelka (Czech Republic)

General Secretary: Peter Ritmeester (The Netherlands)

Board Members: Hendrik Hardeman (India)
Valter Kvalić (Croatia)
Will Shortz (USA)

The WORLD PUZZLE NEWSLETTER 13

Official publication of the World Puzzle Federation

Editorial

A lot of things happened during past twelve months. Two major events, the WPC and WSC took place in Rio de Janeiro and in Goa. We have seen the best puzzlers in action before, and after several years we now have a new face on top. Pal Madarassy from Hungary is a new world champion at the WPC. His accomplishment deserves proper attention, and there is an article about the new world champion in this newsletter. The board of the WPF has been busy lately. It had to make a tough decision by cancelling the WPC in Vilnius, and appointing a new host - at Minsk in Belarus. The board also voted Turkish

Antalya to be the host of 2009 WPC. WPF has grown to over 40 members from all over the world. Some of them have their representatives at every event, while some struggle to cover significant travel expenses and participation fees for their teams.

The global trend of uncertainty did not bypass our organization. For some countries, two events in one year are too much. This is something to be discussed at the WPF assembly in Minsk. See you there!

Vukta Kraljic



Minsk



Antalya



Žilina

The 16th WPC in Brazil 2007

The event

The 16th World Puzzle Championship Brazil 2007 was an amazing proof of the ability and responsibility of all the organizers and participants.

The event took place at the Intercontinental Hotel, Rio de Janeiro from October 06th to October 11th, and was organized by Ediouro Publicações/Revistas Coquetel, Brazilian member of the WPF. Besides the organization, the country has also formed a Brazilian team, which shows its progress since last WPC and its dedication. The event was very importante for Brazil and especially for Latin America as other countries had the opportunity to participate, such as Argentina and Peru.

The teams were extremely focused and ready for the event. On the first day, competitors were seen mainly at the hotel, studying and switching information among other competitors. But even studying a lot, they made time to visit Rio de Janeiro's famous places of interest, such as Corcovado, the Christ Redeemer, and Sugar Loaf.

The countries recognized for their competitiveness were on the top of list since the beginning of the competitions, but



Amazing samba dancers performing at the farewell party



other teams have reached very good positions. The teams appreciate the creativeness of all the puzzles and they were very receptive to doing some of them in groups, especially the "incredible machine" that represents the most interesting engineering puzzle in WPC. The challenge was to make structure using only school materials such as rubberbands, papers, pens, pencils, rulers, and other items like this. The structure

had to be capable of rolling one little ball from point A by the longest way until it reached point B.

We had a wonderful farewell party introducing one of the most famous samba groups, Acadêmicos da Rocinha.

Team results were surprising, as Belgium, Hungary and Japan were the three top countries in individual and country positions.

What made the event unique was the participants presence. They believe Brazil could offer a very well organized and serious event and they did. That's why WPC Brazil 2007 received



Ediouro's staff relaxed after the competitions.



Checking solutions



Another picture from the farewell party.

so many compliments in the end.

The Organizer

Coquetel Magazines is the largest puzzle publisher in Latin America. The original brand, a pioneer in Brazil, was created in 1948, by Ediouro, and nowadays has more than 90 different titles, with more than three mil-

lion copies per month. They are enjoyed by all age groups.

During these years, Coquetel has had a lot of partnerships participating in fashion shows, school projects and even TV quiz shows. Ediouro and Coquetel are also members of the most important international literary event that occurs annu-

ally in Rio de Janeiro and São Paulo, the "Bienal Internacional do Livro". Coquetel Magazines – www.coquetel.com.br - has also entered in the Guinness World Record Book with the biggest crosswords puzzle in the world containing more than 3.200 clues, and the world's biggest wordsearch.

Activities of the German

At the beginning of 2006 seven puzzle-interested people founded a new puzzle federation in Germany, named Logic Masters Deutschland. e.V. The purpose of this activity was first to make logic and mathematic puzzles more popular in Germany and to do something about their distribution, and second, to become an official member of the World Puzzle Federation.

Here are two puzzles from the German puzzle championship 2007. The puzzle author is Bernard Seckinger, one of the puzzlemakers in our federation. (The instructions of the puzzles are the usual. The overlapped puzzle is a mixture of several different logic puzzles.)

The German puzzle federation has so far about 70 members. It organizes 3 championships (for Germany and worldwide) per year :

1) The Open German Optimizing Puzzle Championship — an online tournament with about

solution

Zum Abstreichen beim Domino-Rätsel:

1 7	2 7	3 7	4 7	5 7	6 7
1 6	2 6	3 6	4 6	5 6	
1 5	2 5	3 5	4 5		
1 4	2 4	3 4			
1 3	2 3				
1 2					

200 participants from all over the world.
 2) Logic Masters Deutschland — the German championship with about 400 participants. It includes the chance to qualify for the World Puzzle Championship.

3) German Sudoku Championship — a championship with about 800 puzzlers. It offers the chance to qualify for the World Sudoku Championship.

For 2 and 3: To qualify you must be German but not a

Puzzle Federation

member of our federation.

Additional to these activities we arrange several regional puzzle championships (last year the first Puzzle Championship of Brühl and the first Puzzle Championship of Gießen). We start with talks and lectures on puzzles and we have a really good newsletter called "Denkzettel" which appears four times a year with puzzles, discussions, solution strategies and reports about championships in Germany and worldwide.

Also we organize the participation for the qualified puzzlers in the World Puzzle and Sudoku Championships.

All interested people can look at our activities on our homepage (www.logic-masters.de), can talk in our forum (<http://forum.logic-masters.de/>) and can help to create a list with all known (and till today unknown) types of logic puzzles in our puzzlewiki website (<http://wiki.logic-masters.de/index.php?title=Hauptseite>). Though the main language is (of course) German, most of the texts are also in English. So everybody in the world is invited and warmly welcomed to participate in our activities.

To become a member of our federation it is not necessary to be a German. Everybody in the world can become a member. So we have members from The Netherlands, from Austria and

even from Estonia and Turkey. We are very pleased about new members from Germany and from all other countries. The membership fee is 48 Euros per year, a reduced membership (for example for students) is 36 Euros and persons under 18 years have to pay only 12 Euros.

This is our puzzle schedule for 2008:

29.02.2008: The second Open German Optimizing Puzzle Championship. It is a online tournament in 5 rounds for participants from all over the world. In 2009 we will hold the third Open German Optimizing Puzzle Championship at nearly the same time.

26.04.2008: The qualification round for Logic Masters Deutschland 2008. It is a online qualification test for puzzlers from all over the world.

22.06.2008. The best 25 German participants from the qualification round will be invited to the city of Gotha for the Logic Masters Deutschland 2008. From this tournament we will determine the German Puzzle Champion 2008 and the 4 members of the team for the World Puzzle Championship 2008.

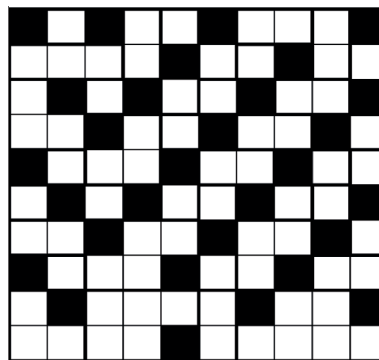
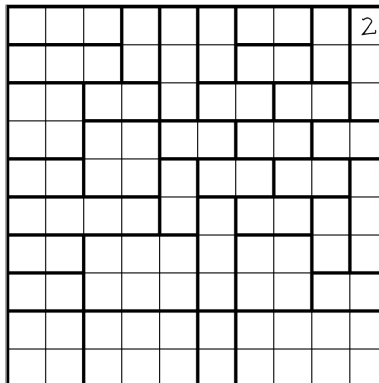

solution

09.2008: The qualification round for German Sudoku Championship 2008. It is a online qualification test for puzzlers from all over the world.

11.2008: The best 60 German participants from the qualification round will be invited to a live final tournament by which we will find out the German Sudoku Champion 2008 and the members of the team for the World Sudoku Championship 2009.

WPC PUZZLES • RIO DE JANEIRO 2007

here are some puzzles that were solved by the competitors at the 16th WPC 2007 in Rio de Janeiro. The instructions that accompany the puzzles are the original, unedited ones.

1. FIVE TIMES CHAMPION

Find out how each of the soccer teams scored a goal. For both teams, their attack ending in a goal started from their goalkeeper, and after all the players of that team touched the ball, the last player kicked the ball to the opponent goal. The ball always moves either horizontally, vertically or diagonally valid if the line starting at the last player ends in the opponents goal.

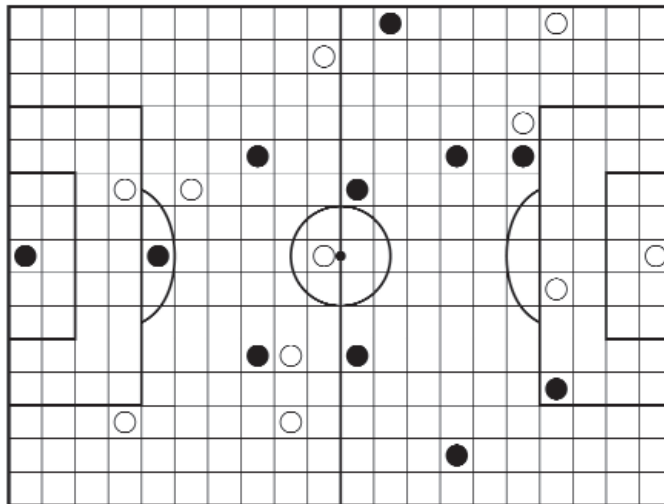

2. TORUS FOUR WINDS

Draw one more horizontal or vertical line from each numbered square on the grid below, which is an open configuration of a torus. Lines cannot cross other numbered squares. Each number indicates how many squares are connected by its line. No line overlaps or intersects another.

					5	
				12		
	1				1	
			9			
						6
	4					
		12				
			1			3

3. ARROWS

Draw an arrow in each square of the diagram border so that every number in the grid indicates how many arrows are pointing to it. Arrows may point right, left, up, down or at a diagonal, but each one must point to at least one number.

	3	5	2	3	4	6
	1	1	2	1	1	3
	4	3	3	4	2	6
	1	3	0	0	3	3
	4	2	2	2	2	7
	2	2	1	2	2	3

A	R	B	L	I	L	I	L	B
S	I	L	S	B	I	S	S	R
A	B	A	R	R	A	B	A	A
S	R	L	B	I	L	R	S	I
I	I	B	S	A	L	B	L	L
S	L	B	R	I	S	R	I	B
A	B	I	R	A	A	S	R	A
R	L	S	A	R	B	L	I	S

4. PASSWORD: BRASIL

Starting in the gray "B" and finishing in the gray "L" (in the center of the grid), draw a path connecting the letters of the word BRASIL (yes, it's written in Portuguese!), in sequence of reading. When you finishing the first word, start again, in the next "B" and so on. The path can travel horizontally, vertically or diagonally and it passes through all squares, without crossing or overlapping itself.

5. IRRIGATORS

The goal is to distribute the irrigators on the squared field. The numbers below the columns represent how many irrigated squares there are in those columns, and the numbers on the right indicate how many irrigators there are on those lines. One square cannot be irrigated by more than one irrigator, nor contain two irrigators. There are two types of irrigators: the x-shaped ones and the +-shaped ones, and both irrigate just the first square to where each of their "arms" points.

	●									
								●		1
										3
										0
										3
										0
										3
●										
4	4	6	4	5	2	3	4	4	4	

WPC PUZZLES • RIO DE JANEIRO 2007

6. LETTER SUDOKU

This is Sudoku with the same rules as the traditional one, but with letters in the numbers places. All latin words shown at diagram side should appear at least once, and can be read vertically, horizontally or diagonally. You don't need to point out the words, only complete the Sudoku.

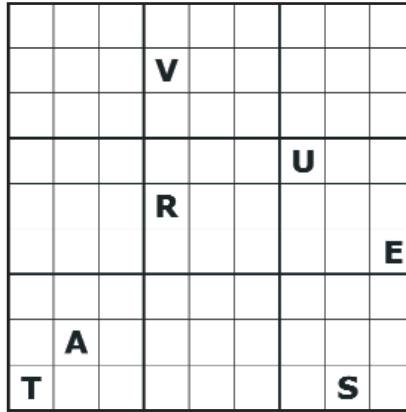

APERTUS
AURES
IPSE
PARI
SUPERAVIT
VERITATIS

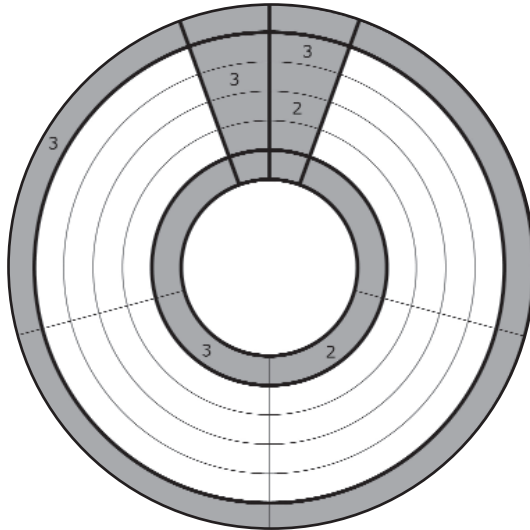

7. CIRCULAR SKYSCRAPERS

Fill the grid with numbers 1, 2, 3, 4, so that each circular sector and annulus contain exactly one instance of all these numbers, representing the height of buildings in a neighborhood. Numbers at the inner and outer annulus and at the top circular sector show the number of visible skyscrapers from that direction (the higher buildings hide the lower ones behind them). At the annulus, use the same logic, considering a curved view along the annulus.

8. EASY AS ABCDE

Every row and column in this grid contained A, B, C, D, and F, although not necessarily in that order. Every letter outside the grid refers to the first of the four shapes encountered when travelling in that direction.

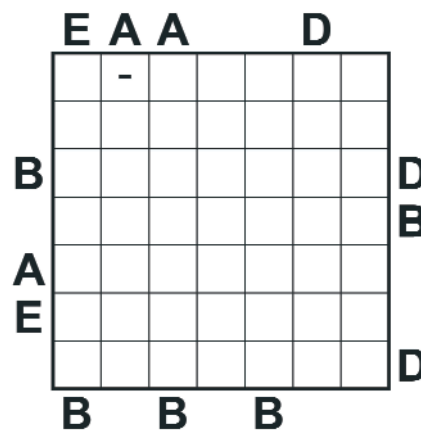

9. THE FINAL LOOP

Draw a single line loop without crossing or overlapping itself, connecting the center of all adjacent white squares.

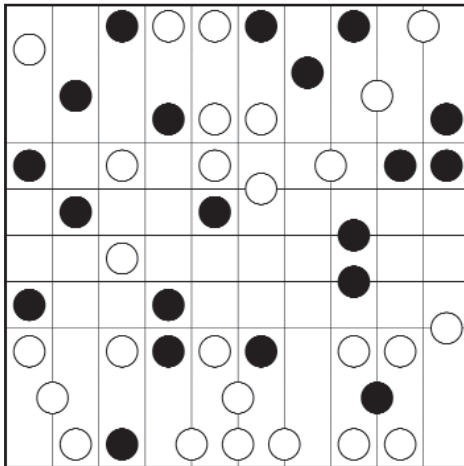
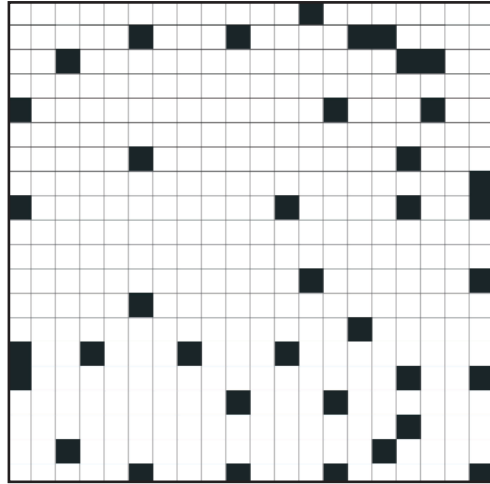

11. STAR BATTLE

Make several squares with stars so that there is an equal number of stars in each row, column and in each area surrounded by thick lines. Stars may not touch each other, not even diagonally. The number of stars in a row is one in the first puzzle and two in the second puzzle.

10. ROTATOR MOSAIC

Divide the grid (along the grid lines) into exactly 10 symmetric pieces (each appearing unchanged if rotated 180°, including its shape and the pattern of any white or black disks). There are no two equal shapes (independent of the pattern).

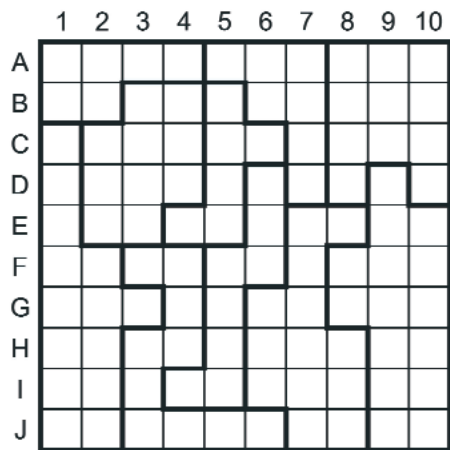

BY GYÖRGY ISTVÁN

Portrait of the

Finally it happened to be the day for Pal Madarassy from Hungary. If you ask him why he won the event, he will answer that it was a unique constellation of the stars.



Picture taken minutes after championship was completed.

The audience of the main conference hall of the Hotel Intercontinental held its breath. It's been a long time since the final has been this exciting; all five participants were solving their fifth and last puzzle to become the world champion. Finally it happened to be the day for Pal Madarassy from Hungary. If you ask him why he won the event, he will answer that it was a unique constellation of the stars: In the final everybody made mistakes enough to be slower than he, and he had luck with every mistake he



Pal Madarassy at his work.

Champion



Another challenge solved quickly and efficiently.

made, as he was able to correct them in 5-10 seconds. But to exploit such an opportunity one has to be very close to the top solvers, so do not speak about the final that it was more luck than merit, but let's see the Hungarian accomplishments in the world of puzzle solving.

If we only want to mention that the Hungarians finished in the top10 in previous WPCs, we will have a list of 7 solvers (Zoltan Gyimesi, Zoltan Horvath, Gyorgy Istvan, Karoly Kresz, Pal Madarassy, Miklos Mocsy, Laszlo Osvalt). The same list contains 9 top 10s for USA, 8 for Japan, 7 for Czech Republic, 5 for The Netherlands and 4 for Germany. Having so many good solvers in a country

is not a surprise at all, since Hungary was the host of the WPC twice (1999 Budapest, 2005 Eger). Indeed, to be a good host you have to have good puzzle-makers, and as it was proven, Hungary has them. Of course this would not be enough without "Georgie" and the Fules magazine, the main organizer and the main sponsor. We have two foremost logical puzzle magazines: the Logika and the Logikoktel, and every year we organize the international 24 Hour Puzzle Championship.

Name: Pal Madarassy
Age: B side of the cassette has just started
Horoscope: Lizard
Hobby: Strategic analyst in OLAF, EU Commission.
Best performance in 2008: Victory in Rio de Janeiro
Worst performance in 2008: Defeat in the French market (with my magazine "Logique Mixte")
Strength: I am not specialized in any type of puzzle, but I do not like basic sudoku.
Weakness: I am not specialized in any type of puzzle, but I do not like basic sudoku.
Practicing methods: 24 hours puzzle championship, solving puzzles when tired, hungry and/or drunk.

Favorite puzzle ever successfully solved: A marvelous puzzle which this margin is too narrow to contain.
Favorite puzzle ever unsuccessfully solved: My girlfriend.



Cancelling a WPC

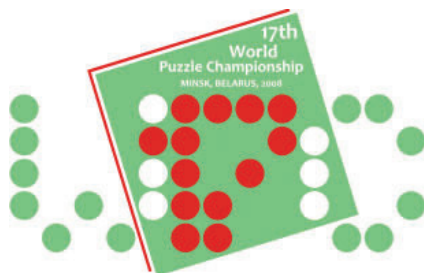

June 2008, the board decided to cancel the WPC 2008 in Lithuania, and have it in Belarus instead. A decision which needs some explaining.

Problems, problems, problems. The first six months of 2008 were quite troublesome. Firstly, the planning was to do an on-line voting for the WPC 2009 in January, but we hesitated.

The reason was that around that time communications with both Hendrik Hardeman, the organizer of the upcoming WSC in India, and Vaidas Rimkus, organizer of the WPC 2008 in Lithuania, were troublesome, to put it mildly. We had to answer a lot of e-mails from members asking us things, because they did not get a response from the relevant organizer.

Although both very capable persons, the problem was that both Hendrik and Vaidas did not have a backup in case they were abroad, too busy or ill.

Clearly, when deciding on the organizer for 2009, we should try to get candidates with an organization backing them up.

The candidates we had in January were either strong individuals but with no organization behind them, or countries that had organized it once or twice already. We also had still in mind the voting for the WPC 2008: Turkey was then the perfect candidate, but lost the vote to Lithuania, mainly because the latter had a nice looking powerpoint presentation, and Turkey had not.

Therefore we decided to give us some more time to get more candidates, and ask Turkey to be a candidate again for 2009.

WSC 2008 In Goa

This was January. In February we had another tough decision to make: how long could we wait with (not) cancelling the World Sudoku Championship in Goa? Communications with Hendrik were still not possible, and lots of members were wondering whether there would still be a WSC.

Some could only get a refund for their plain tickets if they were returned before a certain date. Others had waited with buying those tickets, but waiting too long would mean only extremely expensive ones were left available. So timing was crucial.

We decided to wait as long as possible with a decision, but that we should cancel if the Indian national championship planned in early march would not take place. First of all, we still had the hope of a great championship, and also because most people already bought their tickets. In addition, some members had their national championships spon-



Minsk - The site of the WPC 2008

sored provided the sponsor could also use WSC publicity. Cancelling the WSC could mean that sponsor wanting its money back.

February 16 we received word from an Indian puzzlemaker that he had actually talked with Hendrik and that a message was coming. February 20 everybody could sigh with relief: Hendrik notified all that he had been seriously ill, but starting that day he was fully operational again. Which indeed he was. The WSC in Goa turned out to be a great championship.

Still, two problems left: the WPC 2008 and getting a good candidate for the WPC 2009. Both were discussed in Goa.

WPC's 2008 and 2009

As for the WPC 2009: we had the luxury now of three candidates, one of them being Turkey again, which we very much appreciated. This time they won the election, getting us a great candidate for 2009.

So one problem to go, and a big one: what to do with the WPC 2008? Communications with Vaidas were still hardly possible. And even worse, whenever we managed to get him on the phone, he promised things, but he never lived up to these promises. We had no indication at all that he even had started work.

This was the situation early June, four months before the WPC. Organizing a WPC is a lot more than just creating a few puzzles. To mention one thing: helping puzzlers getting the required visas alone is almost a full time job. Good communications here are vital. These being almost entirely absent, no work at all being done yet, no puzzles being commissioned, and an organizer too busy and not reliable, we lost all faith. We had to cancel, while there was still an option having it organized somewhere else.

We e-mailed, phoned, send an SMS and send a registered letter to tell Vaidas. No response. So to be absolutely sure he got the message, we called the planned hotel in Lithuania: they told us Vaidas had cancelled his reservation.

Minsk, Belarus!

The irony is that the alternative we were so lucky to have, was the one thing we had learned this year we should not do again: one person without an organization backing him up. But Vladimir Portugalov communicated very well, was supported by a large travel agency as the organization and visas are concerned, and by a group of Russian puzzle makers as the competition is concerned.

When you read this, you are probably in Minsk, Belarus, at the WPC 2008, and will know whether we did the right thing. When writing this in early August, I am confident we did.

Report

ON THE 9TH GENERAL ASSEMBLY OF THE WORLD PUZZLE FEDERATION

Rio de Janeiro, October 8-9, 2007

The meeting was called to order by chairman Vitezslav Koudelka (Czech Republic) on October 8 at 14:10. Other board members present were Peter Ritmeester, general secretary (Netherlands); Will Shortz, treasurer (USA); Valter Kvalic (Croatia); and Hüsnü Sincar (Turkey).

The WPF member countries present were Argentina, Austria, Belgium (also representing Denmark), Brazil, Bulgaria, China, Croatia, Czech Republic, Estonia, Finland, France, Germany, Hungary, India, Italy, Japan, Netherlands, Slovakia, Turkey, and United States. Also attending were representatives from nonmember countries Canada and Peru. The meeting was held in two sessions over two days.

Vitezslav opened the meeting by welcoming the participants. The delegates introduced themselves and identified the organizations they represent.

The minutes of the 8th General Assembly of the WPF (Borovetz, Bulgaria), as printed in the World Puzzle Newsletter #12, were approved.

Reports

a) Peter reported that seven new members had joined the WPF during the previous year — organizations representing

Australia, Bangladesh, China, Colombia, Lebanon, Portugal, and Thailand. Most of these, he said, resulted from the worldwide sudoku craze. The WPF now has 43 members.

b) Peter reported that the World Puzzle Newsletter #12 was again done by Tim Preston (UK), but that this would be his last. He solicited a new editor. Tim was given unanimous thanks and approval for his work.

c) Peter handed out a report on the WPF finances. The WPF has a balance of [so many euros]. Will reported that the expenses of 10 WPC teams in Rio de Janeiro were partly underwritten by the WPF, and that approximately 10,000 euros of the WPF surplus were used for this purpose.

It was announced that the membership fee for 2007-08 would again be 250 euros. As always, members from wealthier countries are encouraged to pay more.

d) Vitezslav mentioned that the WPF still needs to prepare guidelines and rules for organizing and running a WPC. Nick Baxter (USA) proposed that the WPF establish an online "wiki" for this purpose, with WPF members contributing to it and editing it. Nick volunteered to set this up himself. He sug-

gested keeping it simple.

Vitezslav volunteered to prepare a document of guidelines for organizing and hosting a WPC/WSC.

Puzzle World Tour

Ferhat Çalapkulu (Turkey) proposed establishing a league of online WPC's in addition to the annual in-person WPC, incorporating the Turkish, Dutch, U.S., German, Argentine, Japanese, Indian, and other national online WPC-like puzzle competitions.

This would be for individual competitors, not teams, and would be the basis for international ratings of participants. iccardo Albini (Italy) said that if we do this, information on national championships must be sent to the WPF, and all WPF members should be notified.

Nick said the WPF website should have links to other sites that offer such competitions.

Also, he said members should make their puzzles readily available to other WPF members.

Will cautioned that contestants' honesty is difficult to check in online competitions. Solvers can use electronic help or have multiple teammates without outside detection. He said in the U.S. Puzzle Championship, director Nick Baxter calls the winners after the tournament and asks them to explain some of

WSC 2008



WSC3 - Individual Rankings (before Playoff)

1	Jakub Ondroušek	Czech Republic	295	570	305	400	475	480	285	2810
2	Thomas Snyder	United States	315	495	395	390	400	300	400	2745
3	Yuhei Kisu	Japan	335	305	305	355	465	375	350	2730
4	Michael Ley	Germany	240	370	370	375	355	330	315	2355
5	Jan Novotný	Czech Republic	330	420	260	275	360	250	240	2235
6	Hidzaki Jo	Japan	305	365	355	395	260	300	190	2160
7	David McNeill	United Kingdom	200	410	355	380	170	360	275	2150
8	Jakub Hradilka	Czech Republic (I)	205	220	325	300	450	250	275	2025
9	Michael Smit	Germany	155	385	270	260	430	250	255	2005
10	Jason Zuffraneri	United States	235	275	245	360	400	185	360	2000
11	Vincent Bertrand	Belgium	130	435	360	270	350	210	285	1990
12	Peter Hudák	Slovakia	170	245	355	355	375	250	205	1955
13	Sumit Dathra	India	220	395	355	240	305	175	230	1925
14	Salih Alin	Turkey	270	300	185	290	410	250	270	1915
15	Tamas Horvath	Hungary	190	290	355	130	435	210	290	1900
16	Zoltan Gyimesi	Hungary	225	375	145	360	315	85	355	1860
17	Daisuke Takei	Japan	245	230	230	255	360	175	265	1860
18	Nikola Ivanovic	Serbia	240	265	145	310	425	210	240	1835
19	Jana Tjovaa	Czech Republic	230	305	250	185	365	175	285	1795
20	Fredérique Rogeeux	France	155	260	295	360	245	330	155	1770
21	Aline Koch	France (I)	250	200	305	360	320	100	285	1760
22	Sebastian Leroy	Belgium	190	155	135	370	445	210	275	1730
23	Mehmet Murat Sevin	Turkey	165	235	125	310	490	175	220	1720
24	Wei-Hwa Huang	United States	170	265	230	255	465	100	230	1715
25	Ritesh Gupta	India	190	275	290	365	345	220	185	1660
26	Karin Griffioen	Netherlands	210	280	270	170	370	210	145	1655
27	Shinichi Aoki	Japan (I)	220	190	270	175	410	150	170	1585
28	Murat Koz	Turkey	220	230	230	190	320	150	240	1580
29	George Danker	United Kingdom	365	310	200	265	200	230	220	1570
30	Olivier Rubin	France	170	245	145	305	470	150	155	1540
31	Jonathan Rivet	United States (I)	235	235	215	185	325	210	125	1530
32	Stefan Gaspár	Slovakia	220	180	180	190	410	150	190	1520
33	Kerstin Witge	Germany	235	335	135	265	330	175	45	1520
34	Rik Uppelschoten	Netherlands	135	185	285	155	260	175	285	1480
35	Pál Madarassy	Hungary	220	145	110	255	315	150	280	1475
36	Michał Karwański	Poland (I)	225	245	215	240	280	160	160	1475
37	Jaipei Reddy Mngilguntla	India (I)	220	230	145	245	295	175	115	1475
38	Hubert Wagner	Germany (I)	225	185	90	195	320	115	210	1370
39	Bojana Voinovic	Serbia	195	195	190	220	335	60	155	1360
40	Rajesh Kumar	India (I)	220	200	90	175	320	150	170	1325
41	Dragan Tokomanoski	Serbia	155	245	200	165	315	100	130	1310
42	Wilbert Zwert	Netherlands	170	200	205	190	260	125	145	1295
43	Michael Alan Collins	United Kingdom	220	185	145	185	300	85	100	1280
44	Ivan Lazar Stefanov	Bulgaria	155	255	105	160	275	150	160	1260
45	Himant Shah	India	165	165	200	175	205	175	155	1240
46	Gaurav Kurde	India (I)	155	285	125	190	305	60	105	1225
47	Dragan Stojanovic	Serbia (I)	175	125	215	130	300	100	155	1200
48	Jocelle Kasneur	Belgium	115	245	85	120	180	360	195	1170
49	Sullen Dyakovski	Bulgaria	100	230	160	170	240	150	115	1165
50	Omkar Hendre	India (I)	85	175	205	115	320	150	95	1145
51	Blanka Lehotska	Slovakia	65	220	90	125	305	100	185	1090
52	Claudine Ihny	Luxembourg (I)	155	165	275	0	240	140	1085	
53	Neyan Barsadov	Bulgaria	160	135	140	80	250	100	180	1085
54	Heinrich Kabyaerud Poulsen	Denmark (I)	30	190	220	250	125	150	115	1080
55	Martin Kollar	Slovakia (I)	65	135	135	240	260	100	105	1040
56	Giulia Franceschini	Italy	180	140	180	140	10	175	115	1040
57	Janus Kayser Gjæve	Denmark (I)	160	155	130	70	265	175	120	1025
58	Jean-Christophe Novelli	France	65	90	175	100	265	175	155	1025
59	Fatma Uoqu Bilic	Turkey (I)	100	240	200	115	100	160	130	1005
60	Li Yiting	China	65	175	40	175	245	140	140	990
61	Jarett Prouse	Canada (I)	220	115	135	110	160	150	65	955
62	MA Kinguang	China	90	160	90	150	200	150	105	945
63	Olja Diaz	Spain (I)	155	205	235	100	55	125	65	940
64	Mike Aisen	Canada (I)	170	145	160	110	215	140	45	940
65	Laura Taruffelli	Italy	45	210	160	195	130	65	95	900
66	Vladimir Portugalov	Bulgaria (I)	175	175	50	175	170	140	155	900
67	Pierdante Lanzavecchia	Italy	0	220	70	125	180	150	110	855
68	Mariene Mira	Portugal (I)	100	185	170	175	95	50	50	875
69	Kristel Tuisk	Estonia	105	130	145	170	130	60	50	790
70	Jacqueline Joyce Oh	Philippines	115	150	100	110	55	60	160	750
71	Maniel Alexis Dion	Philippines	35	115	160	185	115	25	95	740
72	Ain Salula	Estonia	85	155	40	120	65	150	95	710
73	Syrgy István	Hungary (I)	55	115	90	95	100	85	160	675
74	Nahyun Lee	Korea (I)	70	155	90	0	155	60	145	675
75	Simon Anthony	United Kingdom (I)	0	170	50	175	185	85	45	640
76	Li Bu	China	115	75	115	50	80	150	50	635
77	Frederick Ong	Philippines	100	60	10	70	140	125	50	555
78	Cve Jaanson	Estonia	155	65	50	95	100	60	0	525
79	Avijit Sarkar	Bangladesh	85	55	20	50	140	60	0	480
80	WU Kong Jan	Chinese Taipei (I)	10	110	50	130	70	0	50	420
81	Christof Bruebsch	Switzerland (I)	5	70	100	135	55	25	0	390
82	WANG Hongli	China (I)	35	80	115	60	75	25	50	340
83	Mark Skillington	Australia	70	85	65	0	55	60	0	335
84	S.M. Janimul Ahsan	Bangladesh	30	55	55	50	45	0	0	235
85	Sandy Sutherland	Australia	35	0	105	0	25	25	0	190
86	SK. A. S. M. Monirul Islam	Bangladesh	0	55	70	0	25	25	0	175
87	WANG Jia Yao	Chinese Taipei (I)	5	25	50	0	0	0	0	80
88	Hamish Sutherland	Australia	5	15	5	0	25	25	0	75
89	Mick Colless	Australia (I)	5	15	5	0	10	25	0	60



WSC3 - Individual Trophy (after Playoff)

1. Thomas Snyder	USA
2. Yuhei Kusui	Japan
3. Jakub Ondroušek	Czech Republic
4. Jakub Hrazdira	Czech Republic

WSC3 - Team ranking

1	Czech Republic	855	1295	815	860	1200	905	910	2010	1320	10170
2	Japan	885	900	890	1105	1075	750	805	1860	1075	9345
3	Germany	630	1090	775	900	1115	755	615	1730	1290	8900
4	United States	720	985	870	1005	1315	585	980	1920	0	8380
5	Turkey	605	765	540	790	1220	575	730	1550	1075	7850
6	Hungary	635	810	610	745	1065	445	925	1230	875	7340
7	India	575	835	845	585	855	560	570	1010	1075	6910
8	Belgium	335	835	580	660	975	750	755	1650	325	6865
9	United Kingdom	585	905	700	830	670	655	655	940	750	6690
10	Netherlands	515	665	760	515	890	510	575	1010	875	6315
11	Slovakia	455	645	625	670	1090	500	580	870	775	6210
12	France	340	595	615	765	900	655	465	1080	750	6165
13	Serbia	590	705	535	705	1075	370	525	870	300	5675
14	Bulgaria	415	620	405	410	805	400	455	980	300	4790
15	Italy	225	620	410	510	320	390	320	1200	625	4620
16	China	270	410	245	375	525	450	295	870	650	4090
17	Philippines	250	325	270	365	310	210	305	540	650	3225
18	Estonia	345	350	235	385	295	270	145	610	325	2960
19	Bangladesh	115	165	215	100	210	85	0	140	300	1330
20	Australia	110	100	175	0	105	110	0	140	0	740

STATUTES AND REGULATIONS

the name of the federation

1 The federation is known as World Puzzle Federation; abbreviated as: WPF.

seat of the federation

2 The federation will have its seat in Amsterdam.

the time for which the federation is formed

3 The federation is formed for an indefinite period.

the object of the federation

4 The object of the federation is:

- a to provide means for an international exchange of puzzle ideas;
- b to stimulate innovations in the field of puzzles;
- c to supervise the annual World Puzzle Championship (WPC) and other puzzle activities;
- d to foster friendship among puzzle fans world-wide.

the funds of the federation

5 The funds of the federation comprise:

- a members' contributions;
- b income from capital;
- c the profits gained from events organized by the federation;
- d subsidies, donations, property acquired by testamentary succession and legacies;
- e other possible revenues.

the association year

6 The association year is the same as the calendar year

members

7.1 Only legal entities – including those formed according to foreign law – can be representative members of the federation. With the exception of article 7.2, the term 'member' in these statutes always refers to a representative member that is a legal body as described in this article.

7.2 An individual can be a personal member under the conditions described in the Rules and Regulations of the federation. With the exception of this article, the term 'member' in these statutes always refers to a representative member that is a legal body as described in article 7.1.

membership application

8.1 The legal entity wishing to join the federation must apply in writing to the federation board.

8.2 The board decides on the admittance of a member.

8.3 If the board decides not to admit a legal entity as member, it must give the rejected party written notification of the reasons within four weeks after the board's decision.

obligations and rights of the members

9.1 The members must pay a contribution each year; the general assembly determines each year how much this contribution will be.

9.2 The members must meet the stipulations of the articles and rules, the decisions of the board and the general assembly.

9.3 The members must promote the interests of the federation in their own country.

9.4 All members are entitled to attend and to speak at the general assemblies of the federation.

termination of membership

10 Membership terminates:

- a when terminated by a member;
- b when terminated by the board on behalf of the federation;
- c with removal from membership by the general assembly;
- d with the bankruptcy or liquidation of the member.

on termination by the member

11 If a member wishes to terminate its membership, it must give the federation written notice of the same at least thirty days before the end of the association year; in that case, membership will last until the start of the new association year.

on termination of membership by the federation

12.1 The federation can terminate a membership if the member fails to pay its contribution, fails to meet other obligations to the federation or if, for whatever reason, the federation cannot rea-

sonably be expected to allow the membership to continue.

12.2 Termination of the membership on behalf of the federation is done by the board; the board must give the member written notice of the same, stating the reasons for the termination.

on removal from membership by the general assembly

13.1 The general assembly can decide to remove a member from membership; it can take such a decision only if the member acts in conflict with the articles, rules or decisions of the federation or if the member unreasonably injures the federation.

13.2 Immediately after the general assembly has taken such a decision, the board gives the member written notice of the same, stating the reasons for the removal.

on the federation board

14.1 The federation has a board comprising at least three natural persons, but even if the number of board members is less than three, the board continues to be authorized.

14.2 The general assembly selects the board members on the recommendation of the members; each member of the federation can nominate a candidate; such a recommendation must take place in writing at least thirty days before the general assembly; the nominated candidate must have stated his willingness to stand in writing before then.

14.3 The board itself decides which of its members will be chairman, secretary and treasurer; the chairman cannot hold any other board position.

on suspending and dismissing board members

15.1 The general assembly can at any time suspend or dismiss board members.

15.2 If the suspension of a board member is not followed by dismissal within three months, the suspension is terminated.

on the duration and termination of the board membership

16.1 The general assembly appoints the members of the board for a period of three years; after the expiration of a term, a member is immediately re-electable.

16.2 Board membership terminates:

- a with the termination of the period for which the board member was appointed;
- b with dismissal by the general assembly;
- c with the resignation of the board member.

on convening and decision-making by the board

17.1 The board convenes as often as the chairman or two other board members wish, but at least once a year.

17.2 The board can take decisions only if a majority of the board members is present or represented.

17.3 The board takes its decisions based on a simple majority vote.

17.4 If the votes are equally divided, the chairman re-opens the discussion; if the votes are equally divided again, the chairman decides.

17.5 The board can also take decisions outside assemblies if no board members object and if all the board members participate.

17.6 The board must take minutes of all its meetings; in its next meeting, the board must adopt the minutes.

restricting the powers of the board

18. Without the consent of the general assembly, the board cannot enter into agreements concerning the purchase, alienation or objections to registered properties, conclude agreements whereby the federation binds itself as surety or principal joint debtor, support a third party or obligate itself to providing security for the debts of another or whereby the association provides or receives monies in loan.

on the general assembly of the members of the federation

PRESENT MEMBERS

ARGENTINA

EDICIONES DE MENTE

Address:
Corrientes 1312 - 8o
C1043ABN
Buenos Aires
Argentina
Contact:
Mr. Jaime Poniachik, Director
Phone: +54.11.43747907
Fax: +54.11.43743829
E-mail: poniachik@fiber-tel.com.ar

AUSTRALIA

COOCH CREATIVE PTY LTD

Address:
PO BOX 2001
Churchlands
Western Australia, 6018
Australia
Contact:
Mr. Mick Colliss, Director
Phone: +61.8.93837350
Fax: +61.8.93837351
E-mail: mick@cooch.com.au

AUSTRIA

DeBerners Werbung & Grafik GmbH

Address:
Winkler Strasse 936
A-8962 Gröbming
Austria
Contact:
Mr. Michael Riemann, Organisation WPF events
Phone: +49 6349 929 440
Fax: +49 6349 929 442
E-mail: mike.riemann@web.de

BANGLADESH

The Daily Prothom-Alo

Address:
CA Bhaban
100 Kazi Nazrul Islam Avenue
Karwan Bazar
Dhaka
Bangladesh
Contact:
Mr. Shaiful Azim, Event manager
Cell: +88.017.13.067606
E-mail: event@prothom-alo.com

BELGIUM

Keesing Publishers

Address:
Bisschoppenhoflaan 383
2100 Deurne
Belgium
Contact:
Mr. Stefaan Cornilly, Managing Director
Tel: +32.(0)3.360 51 00
Fax: +32.(0)3.324 38 98
E-mail: s.cornilly@keesing.be

BRAZIL

Ediouro Publicações

Address:
Rua Nova Jerusalém, 345
Bonsucesso
Rio de Janeiro/RJ
CEP 21042-235
Brazil
Contact:
Ms. Diana Baptista
Tel: +55-21-3882-8394
Fax: +55-21-2290-7185
E-mail: dianabaptista@ediouro.com.br

BULGARIA

Mensa - Bulgaria

Address:
Mensa - Bulgaria
c-x Levski-G bl.31 entr.A
apt.32
Sofia
Bulgaria
Contact:
Mr. Deyan Razsadov, vice-chairman
Tel: +359.88.8640970
E-mail: deyan@puzzle-bg.com

CHINA

Beijing (News Group) Puzzler Club

Address:
Floor 4, East Wing, Oriental Square
8 - 16 Dongdan Santiao, East City District
Beijing 100005
The Peoples' Republic of China
Contact:
Mr. Zhang Weixiong, president
Mr. George Xingcun Wang, vice-president in charge of international affairs
Tel: +00.44.2089770236
E-mail: icb.uk.office@gmail.com

COLOMBIA

Grupo Editorial Adria Ltda (GEA)

Address:
Carrera 44 Nr. 13-77
Bogota
Colombia
Contact:
Mr. Domingo Jaramillo, manager
Tel: +571.268.5529
Fax: +571.268.5529
E-mail: djaramillo@grupoadria.com

CROATIA

Hrvatski Zagonetacki Savez (Croatian Puzzle Federation)

Address:
FENIKS, Pero Galogaza
Hrvatski Zagonetacki Savez
Zvonimirova 20 A
51000 Rijeka
Croatia
Contact:
Mr. Pero Galogaza, president
Tel: +38.551650105
Fax: +38.551672114
E-mail: nl-feniks@novi-list.htnet.hr

CHECH REPUBLIC

SCHAK (Svaz ceskych hádankáru a krizovkáru)

Address:
Brigadniku 2919/69
100 00 Praha 10
Czech Republic
Contact:
Mr. Vítězslav Koudelka, chairman WPF
KIRA Publishing House
Horova 73
616 00 Brno 16
Czech Republic
Tel: +420.546 210 175
Fax: +420.546 210 175
E-mail: kira@kira.cz

DENMARK

Keesing Krydsordsforlaget A/S

Address:
Bernhard Bangs Alle 23
DK-2000 Frederiksberg
Denmark
Contact:
Mr. Kim Gleerup, General Manager
Phone: +45 3818 3817
Fax: +45 3888 7032
E-mail: k.gleerup@keesing.dk

ESTONIA

As Kuma

Address:
Pärnu tn 57
72712 Paide
Estonia
Contact:
Mr. Jaanus Laidna, editor-in-chief crossword magazines
Tel: +372.383.8829
Fax: +372.383.8806
E-mail: jaanus@kuma.ee

FINLAND

Suomen puzzle-harrastajat Ahaa!

(Finnish Puzzle Association Aha!)

Address:
AHAA-lehti
Paukkapojantie 6
FIN-90800 OULU
Finland
Contact:
Mr. J.P. Ikäheimonen
Tel, gsm: +358-40-738 5138
E-mail: jp.ikaheimonen@elisaneet.fi

FRANCE

KEESING FRANCE

Address:
9, place Marie-Jeanne
Bassot
92693 Levallois-Perret
Cedex
FRANCE
Contact:
Mr. Xavier de Bure, Managing Director
Tel: +33.1.41490959
Fax: +33.1.41490989
E-mail: pfroideval@keesing.fr

GERMANY

Logic Masters Deutschland e.V.

Address:
Kleiststr. 2
50321 Brühl
Germany
Contact:
Johannes Susen, Chairman
Tel: +49.2232.942509
Fax: +49.2232.942508
E-mail: kontakt@logic-masters.de

PRESENT MEMBERS

HUNGARY

Rejtvényfejtők Országos
Egyesülete
(Hungarian Puzzlers' As-
sociation)

Address:
ROE
POB. 13
1752 Budapest
Hungary
Contact:
Mr. György István, presi-
dent
Phone: +36-1-210-3956
Fax: +36-1-210-3956
E-mail: roe@chello.hu

INDIA

Novax Media Pvt. Ltd.

Address:
No. 1240, 10th Main,
12th 'B' Cross, II Stage
West of Chord Road
Bangalore 560086
INDIA
Contact:
Mr. Hendrik Hardeman,
Managing Director
Tel: +91.80.23498695
Fax: N/A
E-mail: hendrik.harde-
man@gmail.com

ITALY

Nonzero srl

Address:
Viale Sondrio 7
20124 Milano
ITALY
Contact:
Riccardo Albini, Publishing
Director
Tel: +39 0245495151
Fax: +39 025495303
E-mail: ralbini@nonzero.it

JAPAN

Sekai-bunka Publishing
Inc.

Address:
4 - 2 - 29 Kudan-kita
Chiyoda-ku
102-8187 Tokyo
Japan
Contact:
Tsutomu Takema, editor-in-
chief
Tel: +81.3.3262.5125
Fax: +81.3.3262.5330
E-mail: puzzle@sekai-
bunka.co.jp

KOREA

Puzzleland Co.

Address:
#501, Joongang building,
44-26
Youido-dong
Yeodegpo-gu
Seoul 150-741
KOREA
Contact:
Mr. J. B. Park, Director
Phone: 82.2.761.2071
Fax: 82.2.761.2073
E-mail:
paco@puzzleland.co.kr

LATVIA

Sia Kuma

Address:
Rinuzu iela 22-44
Riga
LV-1015
LATVIA
Contact:
Mr. Ricards Korallis, editor
crossword magazines
Phone: +371.9494.517
Fax: +371.734.2879
E-mail: korallis@kuma.lv

LEBANON

Implicit Consultants Sarl

Address:
Sin El Fil, Technomania
bldg, 5th floor
PO Box: 90 - 1774
Jdeideh
LEBANON
Contact:
Ms. Elsa Hajjar, Project
Manager
Phone: +961-1-480 200
Fax: +961-1-48 89 89
E-mail: implicit@idm.net.lb

LITHUANIA

Lithuania puzzle club

Address:
Naugarduko str. 99-306
Vilnius
Lithuania
Post Address:
PO BOX 921
LT - 04016 Vilnius - 50
Lithuania
Contact:
Mr. Vaidas Rimkus, Presi-
dent
Mobile Phone:
+370.65220963
Fax: +370 5 2784387
E-mail: info@galvosukiai.lt

MALAYSIA

iMINDgination Sdn Bhd

Address:
iMINDgination Sdn Bhd
15 & 17, Jalan Gangsa
SD5/3G
Bandar Sri Damansara
52200 Kuala Lumpur
Malaysia
Contact:
Mr. Low Keng Lok; Director
Phone: +6019 2749363
Fax: +603 62747876
E-mail:
kenglok@tm.net.my

PERU

Revista Mente Brillante
(Servicios Educativos
Gauss S. A.)

Address:
Jiron Pukin 131
Urbanizacion Tungasuca
Distrito Carabayllo - Lima 6
Lima
Peru
Contact:
Aurelio Chavez, director of
the Magazine
Tel: +511.5431191
Fax: +511.5430019
E-mail: mentebrillante@in-
fonegocio.net.pe

PHILIPPINES

Mathematics Trainers'
Guild, Philippines

Address:
c/o Zamboanga Chong
Hua High School
General Vicente Alvarez St
7000 Zamboanga City
Philippines
Contact:
Dr. Simon L. Chua, presi-
dent
Tel: +63.629923045 /
+63.9178479525
Fax: +63.629923045
E-mail:
simon_l_chua@yahoo.com

POLAND

SFINKS
Polish Society of Games
and Puzzle Fans
www.sfinks.org.pl

Address:
ul. Bialostocka 9/184
03-741 Warszawa
Poland
Contact:
Mr. Jacek Szczap, Presi-
dent
Tel: +48.22.6180090
Tel GSM: +48.501723622
E-mail: jszczap@medi-
agames.pl

PORTUGAL

FUN - COMUNICAÇÃO E
EVENTOS, LDA.

Address:
Rua A Gazeta de Oeiras, 2
- 3º A
A Edifício Horizonte 2780-
171
Oeiras
Portugal
Contact:
Ms. Georgina Lima, Events
Assistant
Tel: +351 21 441 81 82
Fax: +351 21 441 82 83
E-mail: mail@fun.pt

ROMANIA

Asociația "Logic Club"

Address:
Str. ALUMINEI nr. 68, bl. B-
4, sc. B, ap. 4
ORADEA, jud. BIHOR, cod
410313
ROMANIA
Contact:
Mr. Stelian-Radu Cacuci,
president
Tel: +40.744.346696 (mo-
bile)
Fax: +40.259.437537
E-mail:
logic.club@gmail.com
Website:
www.geocities.com/logic.cl
ub

RUSSIA

Logos Media Publishing
Group

Address:
49-1, Vyatskaya str.
Moscow, 125015
Russia
Contact:
Ms. Olga Leontieva, editor
Tel: +7.095.932.7968
Fax: +7.095.974.7900
E-mail: 9360.g23@g23.rel-
com.ru

SERBIA

Savez zagonetaca Srbije
(SZS)

Address:
Narodnog fronta 18
21000 Novi Sad
Serbia
Contact:
Mr. Zoran Tanasic, Presi-
dent
Tel: +381.63.604014
Fax: +381.21.528525
E-mail: zoran.tanasic@li-
paks.co.yu

PRESENT MEMBERS

SINGAPORE

Affinity Education Place
Address:
32 Wallich Street
#03 - 61, Wallich Building
Singapore 078880
Contact:
Mr. Quek Ee Meng, Principle of the school
Tel: +(65) 9793 5385
Fax: +(65) 6744 3338
E-mail:
qeemeng@singnet.com.sg

SLOVAKIA

Slovenský zväz hádankárov a križovkárov
Visiting Address:
M. Dulu 34 / 74
MARTIN, 036 08
SLOVAKIA
Contact:
Mr. Ján Farkas, chairman
Tel: +421.902.264247
E-mail: szhk@szhk.sk

SPAIN

Ediciones Primera plana S.A.
Address:
Consell de cent, 425
08009 Barcelona
ID-number: A-28557908
Spain
Contact:
Ms. Nuria Quiñones
Tel: +34.93.265.5353
Fax: +34.93.484.6533
E-mail: nquinones@elperiodico.com

SWITZERLAND

Swiss Puzzle Federation
Address:
Rue Gustave-Moynier 1
1202 Geneva
Switzerland
Contact:
Mr. Mark Stenzler, President
Phone: +41 1 940 0728
E-mail: puzzles@active.ch

THAILAND

Thailand Crossword Game, A-Math, Kumkom, and Sudoku Association
Address:
631, 633, 635 Rama 3 Road
Bangpongpan, Yannawa
Bangkok 10120
Thailand
Contact:
Mr. Amnuay Ploysangnam, president
Phone: +66.2.6819971
Fax: +66.2.6819974
E-mail: info@thaicrossword.com

THE NETHERLANDS

Keesing Nederland bv (Puzzelsport)
Visiting Address:
Address:
Hogehilweg 13
1101 CA Amsterdam
The Netherlands
Mail Address:
Postbus 1118
1000 BC Amsterdam
The Netherlands
Contact:
Jan Lam, managing editor
Tel: +31 (0)20 5641 840
Fax: +31 (0)20 5641 845
E-mail: j.lam@keesing.nl

TURKEY

Akıl Oyunları Ltd. Şti.
Address:
Caferağa Mah.
Arayıcıbaşı Sok. No:15/3
Kadıköy 34710
Istanbul
TURKEY
Contact:
Mr. Kamer Alyanakyan, Managing Director
Tel: +90 (216) 450-3055
Mobile: +90 (533) 560-3004
Fax: +90 (216) 450-3053
E-mail: kamer@akiloyunlari.com

UKRAINE

Publishing House "TV-Park" - "Crosswords&Puzzles" Newspaper
Address:
Publishing House "TV-Park" - "Crosswords&Puzzles" Newspaper
Ms. Irene Kiryatskaya, Editor-in-Chief
6 Krasnykh Kazakov Avenue
Kyiv 04073
Ukraine
Contact:
Mr. Serhiy Grabarchuk, Adviser
Tel: +380-31-2-671876
Fax: +380-31-2-671876
E-mail: serhiy-g@karpaty.uzhgorod.ua

UNITED KINGDOM

Puzzler Media
Address:
Stonecroft
69 Station Road
Redhill RH1 1EY Surrey
United Kingdom
Contact:
Mr. Tim Preston, Publishing Director
Tel: +44.1737.378730
Fax: +44.1737.781800
E-mail: tim.preston@puzzlermedia.com

URUGUAY

Grupo Ingenio Uruguay
Address:
Javier de Viana 2356
Montevideo, Postal Code 11222
Uruguay
Contact:
Ms. Débora Saviotti, Board Director
Tel: +598.2.613.5639
Fax: +598.2.411.7743
E-mail: home@gruopoingeniouruguay.com
Website:
http://www.gruopoingeniouruguay.com

U.S.A.

U.S. Puzzle Championship
Address:
Will Shortz
55 Great Oak Lane
Pleasantville, NY 10570
U.S.A.
Contact:
Mr. Will Shortz, Director
Tel: +1.914.769 9128
Fax: +1.914.769 9128
E-mail: wshortz@aol.com

SOLUTIONS

1. FIVE TIMES CHAMPION

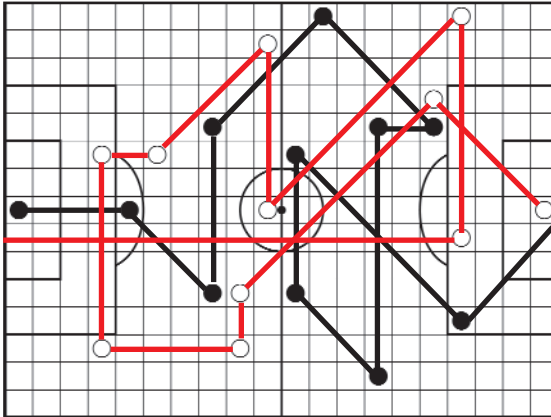

2. TORUS FOUR WINDS

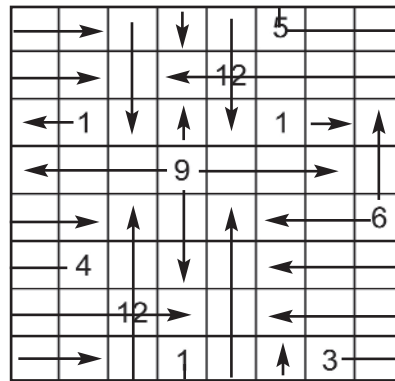

3. ARROWS

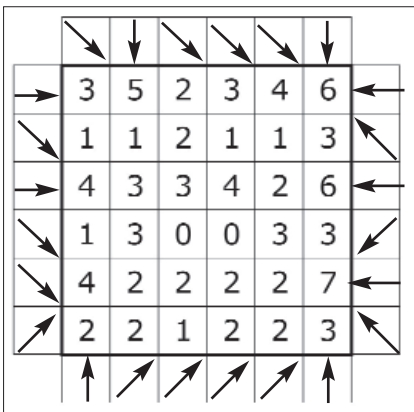

4. PASSWORD: BRASIL

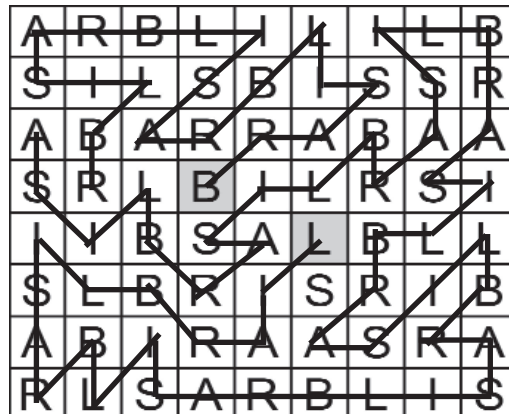

5. IRRIGATORS

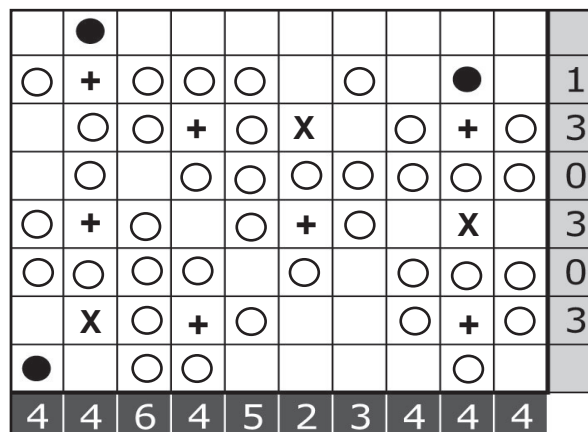

6. LETTER SUDOKU

S	U	P	E	R	A	V	I	T
E	I	A	V	U	T	P	R	S
V	R	T	I	P	S	E	A	U
I	S	V	A	E	P	U	T	R
A	P	E	R	T	U	S	V	I
U	T	R	S	V	I	A	P	E
P	V	I	T	S	E	R	U	A
R	A	S	U	I	V	T	E	P
T	E	U	P	A	R	I	S	V

APERTUS
AURES
IPSE
PARI
SUPERAVIT
VERITATIS

7. CIRCULAR SKYSCRAPERS

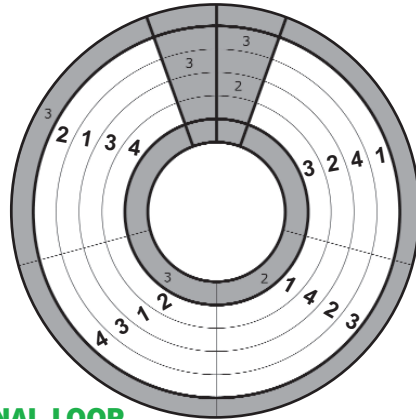

8. EASY AS ABCDE

E	A	A		D			
E	-	A	C	D	B		
D	A		B	C	E		
B		B	C	A	E	D	B
	C	D	E		A	B	B
A	A		D		B	E	C
E		E	B	D		C	A
	B	C		E	A	D	D
B	B	B					

9. THE FINAL LOOP

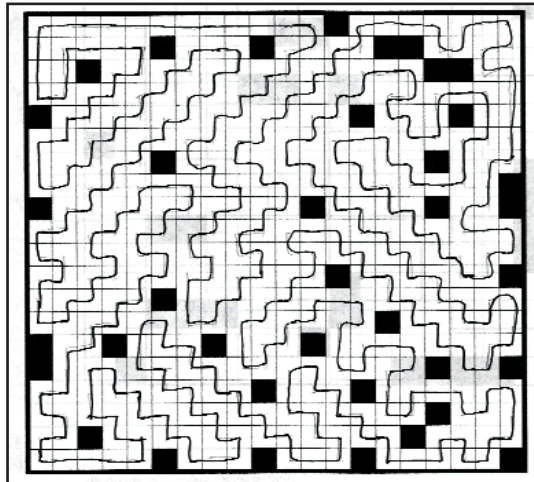

10. ROTATOR MOSAIC

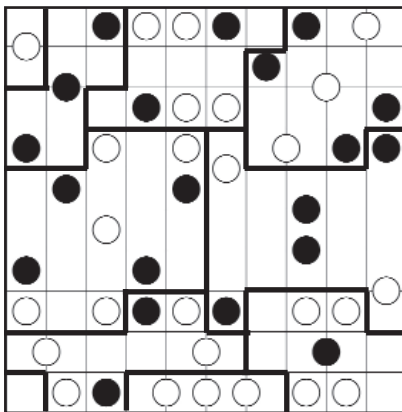

11. STAR BATTLE

	1	2	3	4	5	6	7	8	9	10
A	●			●						
B							●		●	
C		●			●					
D							●			●
E		●		●						
F						●			●	
G	●		●							
H				●				●		
I			●							●
J						●		●		



World Puzzle Federation Head Office

Kruislaan 419 - 1098 VA Amsterdam - The Netherlands
Tel/Fax: +31.20.8884643 - E-mail: office@worldpuzzle.org



www.worldpuzzle.org

their solutions so he can verify they did the work themselves. And since the USPC has no monetary prizes, there is little reason for anyone to cheat. With any online competition, though, he said cheating is a constant concern. Hendrik Hardeman (India) cautioned that the Indian online puzzle championship has limited bandwidth, so in the past the Indian contest has been limited to Indians. Countries should have the right not to participate in the proposed league. Jaime Poniachik (Argentina) and others recommended that we try the proposed Puzzle World Tour and see if it works. Nick suggested that contestants sign up for the tour in advance and get registration numbers. Ferhat will oversee the results and ratings for the tour, which, at the end of the year, will be posted on the WPF website.

Combining the WPC and WSC

Jan Lamm (Netherlands) proposed combining the World Puzzle Championship and World Sudoku Championship in 2009, because of the cost and time commitment involved in attending both events. The two championships would be held in the same city, one after the other. Alternatively, if members want to continue both events separately, he recommended alternating the events — holding the WPC one year and the WSC the next.

There was much discussion pro and con on the desirability/advantages of combining the events and the practical problems of doing so. Will proposed that the WPF postpone a decision on the mat-

ter until the next congress, in 2008, in order to give members more time to reflect. The vote was 7 in favor of deciding immediately, and 10 in favor of deciding later.

A vote was then held on when "later" would be. In favor of deciding at the WSC in Goa, India, in April 2008 — 0 votes; in favor of deciding by email after Goa, but before the next WPC — 0; in favor of deciding at the next WPC — unanimous.

Finally, an informal, nonbinding vote was held on members' current leanings. In favor of keeping the WPC and WSC separate as they are — 10; in favor of combining the two events — 5; in favor of alternating them — 4.

"Classic" Sudoku versus Variations

Members discussed what percentage of WSC puzzles should be "classic" sudoku and what percentage should be variations. Nick has set up a forum for discussion online.

Election of Board Members

Two people — Valter Kvalic (Croatia) and Will Shortz (USA) — were nominated to fill the two open positions on the WPF board. Both were seeking reelection. Each spoke for a few minutes about his hopes and plans for the WPC/WPF and why they wanted to continue on the board. Each was reelected unanimously.

Site Selection for the 2009 WPC

Vitezslav reported that no members had offered to host the 2009 WPC.

The board proposed extending

the deadline for offers until Dec. 31, 2007. At that time the board would notify all the members of the candidate or candidates. The vote for the 2009 WPC site would then be done by email.

Site Selection for the 2009 WSC

Vitezslav announced two candidates for the 2009 WSC — Croatia and Slovakia. Valter Kvalic spoke in favor of the northern coast of Croatia. Jan Farkas made a presentation for Zilina, Slovakia. The vote was 18-3 in favor of Slovakia.

Statements from the 2008 WPC and WSC Organizers

Vaidas Rimkus (Lithuania), who could not attend the 2007 WPC in person, reported by email on the 2008 WPC. He announced it will be held Oct. 18-22 at the Reval Hotel in Vilnius. Further details to come.

Hendrik made a presentation on the 3rd WSC, to be held April 14-18 in Goa, India. He said there will be three competitors per country rather than four (to reduce the cost of countries sending teams), and the competition will focus more on classic sudoku than was done in Prague.

Closing

The members thanked Ediouro for a superbly run WPC. There being no further business, the meeting was adjourned on October 9 at 13:40.

WPC 2007 - TEAMS



Germany - Michael Ley, Ulrich Voight, Susanne Koderrisch, Johannes Susen, Hartmut Seeber.



Argentina - Rodolfo Kurchan, jajme Poniachik, Diego Pohorski, Fernando Lopez Gregorjo, Pablo Milrud, Hector Rebottaro.



Austria - Stefan Leopoldseder, Eva Schuckert, Elisa Zancolo, Matthias Reichmayr.



Belgium - Sebastien Leroy, Claude Desset, Peter Tordoir, Bart Leemans, Philippe Niederkorn



Brazil - Carlos Alves, Sandro Guzzo, Marcelo Silvestronni, Leonardo Facci



Bulgaria - Artur Kirkoryan, Galina Cherneva, Anton Titov, Georgi Benev, Deyan Razsadov, Desislava Razsadova, Ognyan Razsadov.



Canada - (not in order) Byron Calver, Derek Kisman, David Savitt, John Wentmiller.



Croatia - Gordan Knežević, Luka Pavičić, Valter Kvalić, Vinko Čarija, Pero Galogaža, Goran Vodopija, Andrej Ivankov

WPC 2007 - TEAMS



Slovakia - Ivan Pastucha, Peter Hudak, Dagmar Severova, Štefan Gašpar, Blanka Lehotska, Jan Farkaš.



Estonia - Jaanus Laidna.



France - (not in order) Vincent Riviere, Denis Auroux, Aline Koch, Jean-Christophe Novelli, Marie Platel.



The Netherlands - Jan Lam, Hans Eendebak, Tim Peters, Rick Uppelschoten, Niels Roest, Bram de Laat



Hungary - Pal Madarassy, Zoltan Horvath, Gyorgy Istvan, Zoltan Eros, Anita Kerek, Jozsef Ludanyi.



India - (not in order) Amit Sowani, Ritesh Gupta, Hendrik Hardeman, Rajesh Kumar, Sumit Bothra.



Poland - (not in order) Pawel Kwiatkowski, Tomasz Krajewski, Jakub Caban, Michal Karwanski.



Russia - (not in order) Riad Khanmagomedov, Andrey Tremba, Alexey Oleshov, Mikhail Kuznetsov.

WPC 2007 • TEAMS



Serbia - Dragan Tolomanoski, Marko Obradović, Zoran Radisavljević, Nikola Živanović.



Turkey - Feza Odabasisincar, Husnu Sincar, Ferhat Calapuklu, Mehmet Murat Sevim, Salih Alan, Aziz Ates.



USA - Zack Butler, Roger Barkan, Helene Hovanec, Nick Baxter, Nancy Schuster, Will Shortz, Wei-Hua Huang, Stan Newman, Thomas Snyder.



Japan - Tsutomu Tahema, Hidekai Jo, Tatsya Yamamoto, Taro Arimatsu, Ko Okamoto, Tetsuya Nishio.



Czech Republic - Robert Babilon, Jan Novotny, Jana Tylova, Petr Nepovim, Vitezslav Koudelka.



Peru - Daniel Yalta, Ivan Royas, Miguel Tomas, Felix Maldonado, Enrique Garcia, Aureilo Chavez.



Romania - Stelian-Radu Cacuci, Andrei Nicusan, Florentina Varga, Hunor Daday, Alexandru Szoke, Andreas Bolota



Finland - Sakari Hakala, Juha Hyvonen, Erja Gullsten, Jouni Sarkijarvi.

WPC2007 • TEAM RESULTS



Position	Country	Part												Score
		1	2	3	4	5	6	7	8	9	10	11	12	
1	United States of America	778	2.336	0	1.008	779	1.302	804	1.726	358	0	699	924	10.714
2	Japan	817	2.063	0	1.067	607	594	874	1.806	286	83	549	924	9.670
3	Belgium	757	1.869	0	1.016	521	584	781	1.619	332	0	536	1.068	9.083
4	Netherlands	698	1.806	0	1.005	717	600	816	1.642	344	0	520	920	9.068
5	France	733	1.798	0	960	598	890	754	1.588	340	0	489	904	9.054
6	Czech Republic	728	1.845	0	918	714	590	741	1.616	324	0	487	1.026	8.989
7	Hungary	735	2.108	0	969	597	576	753	1.532	276	0	507	902	8.955
8	Poland	739	1.694	0	925	565	577	759	1.655	294	25	639	988	8.860
9	Germany	761	2.124	240	797	642	1.019	789	1.659	280	0	541	0	8.852
10	Canada	738	1.738	0	947	685	566	753	1.484	314	0	467	930	8.622
11	Turkey	716	1.790	0	952	565	535	728	1.733	240	0	390	971	8.620
12	Croatia	706	1.649	0	704	678	482	735	1.568	270	67	399	910	8.168
13	India	667	1.690	0	748	599	587	748	1.538	228	0	344	908	8.057
14	Austria	698	1.628	0	691	604	539	760	1.437	240	0	524	904	8.025
15	Brasil	679	1.613	0	758	543	574	707	1.460	276	0	423	906	7.939
16	Bulgaria	677	1.644	0	786	499	546	714	1.492	198	0	417	920	7.893
17	Serbia	579	1.663	0	809	701	563	704	1.368	250	0	331	904	7.872
18	Romania	671	1.558	0	735	565	584	674	1.438	218	0	447	960	7.850
19	Slovakia	721	1.916	0	847	576	566	765	1.638	240	0	535	0	7.804
20	Argentina	652	1.538	0	732	543	504	673	1.278	210	25	382	906	7.443
21	Russia	604	1.561	0	768	499	535	653	1.266	236	0	298	918	7.338
22	Italy	608	1.525	0	663	554	511	645	1.175	280	0	395	908	7.264
23	Peru	380	876	0	203	466	308	400	567	188	0	60	0	3.448

WPC2007 - INDIVIDUAL RESULTS



1. Pal Madarassy
2. Thomas Snyder
3. Ulrich Voigt



Position	Name	Country	Part											Score
			1	2	4	5	7	8	9	10	11			
1	Pal Madarassy	Hungary	181	565	264	144	202	441	78	0	156	2.031		
2	Thomas Snyder	United States of America	196	661	263	250	202	437	96	0	175	2.280		
3	Ulrich Voigt	Germany	191	609	272	210	202	432	70	0	143	2.129		
4	Okamoto Ko	Japan	240	545	235	165	225	495	86	0	170	2.161		
5	Arimatsu Taro	Japan	191	535	273	165	201	433	70	83	148	2.099		
6	Niels Roest	Netherlands	195	480	263	205	216	410	94	0	161	2.024		
7	Wei-Hwa Huang	United States of America	196	570	271	144	202	441	90	0	183	2.097		
8	Sébastien Leroy	Belgium	196	591	266	144	197	420	90	0	156	2.060		
9	Roger Barkan	United States of America	195	570	249	210	202	420	86	0	177	2.109		
10	Zoltan Horvath	Hungary	200	630	258	144	198	428	60	0	123	2.041		
11	Goran Vodopija	Croatia	191	448	198	257	202	427	90	67	126	2.006		
12	Zack Butler	United States of America	191	535	225	175	198	428	86	0	164	2.002		
13	Byron Calver	Canada	191	465	264	253	182	398	90	0	156	1.999		
13	Peter Hudak	Slovakia	195	560	256	144	202	477	50	0	115	1.999		
15	Michael Ley	Germany	196	619	201	144	202	425	70	0	129	1.986		
16	Stefan Gaspar	Slovakia	196	565	227	144	190	429	70	0	162	1.983		
17	Mehmet Murat Sevim	Turkey	196	448	271	144	202	538	70	0	113	1.982		
18	Jo Hideaki	Japan	191	535	276	144	198	441	70	0	108	1.963		
19	Nikola Zivanovic	Serbia	195	495	268	232	198	426	70	0	74	1.958		
20	Rick Uppelschoten	Netherlands	181	446	264	203	202	420	86	0	148	1.950		

21	Yamamoto Tatsuya	Japan	195	448	283	133	250	437	60	0	123	1.929
22	Jana Tyllova	Czech Republic	187	520	261	144	190	424	78	0	121	1.925
23	Jan Novotny	Czech Republic	181	441	249	243	171	418	90	0	124	1.917
24	Denis Auroux	France	187	485	256	150	190	392	90	0	162	1.912
25	Derek Kisman	Canada	191	445	254	144	199	403	94	0	143	1.873
26	Pawel Kwiatkowski	Poland	192	433	228	144	195	428	78	0	169	1.867
27	Tomasz Krajewski	Poland	191	446	234	133	198	413	60	25	164	1.864
28	Amit Sowani	India	181	434	271	144	198	429	78	0	115	1.850
29	Philippe Niederkorn	Belgium	187	433	256	133	193	418	78	0	142	1.840
29	Bram de Laat	Netherlands	165	448	239	165	214	441	86	0	82	1.840
31	Robert Babilon	Czech Republic	191	443	184	183	190	427	86	0	129	1.833
32	Gyorgy Istvan	Hungary	177	470	207	176	193	373	78	0	142	1.816
33	Dragan Tolomanoski	Serbia	153	447	239	225	156	405	60	0	126	1.811
34	Aline Koch	France	168	441	239	160	193	395	86	0	126	1.808
35	Salih Alan	Turkey	181	470	216	144	190	437	70	0	94	1.802
36	Jakub Caban	Poland	178	367	247	144	190	420	86	0	164	1.796
37	Bart Leemans	Belgium	187	441	245	133	198	404	86	0	99	1.793
38	Alexandru Szoke	Romania	191	431	205	144	193	410	78	0	129	1.781
39	Jean-Christophe Novelli	France	191	455	249	144	195	405	78	0	53	1.770
39	Marie Platel	France	187	417	216	144	176	396	86	0	148	1.770
41	Michal Karwański	Poland	178	448	216	144	176	394	70	0	142	1.768
42	Stefan Leopoldseder	Austria	187	445	240	150	190	381	50	0	123	1.766
43	Aziz Ates	Turkey	191	437	216	144	171	420	60	0	110	1.749
44	Susanne Koderrisch	Germany	187	448	160	144	187	404	70	0	148	1.748
45	Claude Desset	Belgium	187	404	249	111	193	377	78	0	139	1.738
46	Tim Peeters	Netherlands	157	432	239	144	184	371	78	0	129	1.734
47	Hartmut Seeber	Germany	187	448	164	144	198	398	70	0	121	1.730
48	Artur Kirkoryan	Bulgaria	187	418	232	144	172	395	78	0	101	1.727
49	Riad Khanmagomedov	Russia	187	450	240	144	190	389	50	0	74	1.724
50	Matthias Reichmayr	Austria	181	431	188	160	195	358	60	0	143	1.716
51	Andrey Tremba	Russia	187	400	247	133	190	374	60	0	110	1.701
52	Petr Nepovim	Czech Republic	169	441	224	144	190	347	70	0	113	1.698
53	Deyan Razasadov	Bulgaria	177	423	197	133	202	413	50	0	101	1.696
54	Vinko Carija	Croatia	179	419	218	144	166	372	70	0	113	1.681
55	Dagmar Severova	Slovakia	153	418	207	144	180	371	50	0	156	1.679
56	Leonardo Bespalhuk Facci	Brasil	177	423	182	144	175	396	78	0	99	1.674
57	David Savitt	Canada	187	423	197	144	182	379	70	0	68	1.650
58	Stefano Forcolin	Italy	169	422	211	144	174	340	90	0	95	1.645
59	Bernhard-Andreas Bolota	Romania	160	397	223	133	165	396	40	0	129	1.643
60	Carlos Eduardo Alves	Brasil	168	423	201	133	195	323	70	0	127	1.640
61	Gabriele Simionato	Italy	179	402	189	144	159	346	90	0	117	1.626
62	Andrej Ivankov	Croatia	149	434	132	144	187	395	50	0	129	1.620
63	Georgi Benev	Bulgaria	153	419	232	111	166	356	50	0	129	1.616
64	Pablo Milrud	Argentina	168	386	232	144	172	356	50	0	98	1.606
65	John Wetmiller	Canada	169	405	232	144	190	304	60	0	100	1.604
66	Ritesh Gupta	India	169	422	139	144	190	405	60	0	70	1.599
67	Anita Kerek	Hungary	177	443	240	133	160	290	60	0	86	1.589
68	Rajesh Kumar	India	177	427	181	111	184	363	40	0	99	1.582
69	Husnu Sincar	Turkey	148	435	249	133	165	338	40	0	73	1.581
70	Ivan Pastucha	Slovakia	177	373	157	144	193	361	70	0	102	1.577
71	Marcello Silvestroni	Brasil	177	388	208	133	150	377	50	0	90	1.573
72	Eva Schuckert	Austria	160	427	147	150	185	327	60	0	116	1.572
72	Sandro Marcos Guzzo	Brasil	157	379	167	133	187	364	78	0	107	1.572
74	Sumit Bothra	India	140	407	157	200	176	341	50	0	60	1.531
75	Elisa Zancolo	Austria	170	325	116	144	190	371	70	0	142	1.528
76	Alexey Oleshov	Russia	170	352	188	111	176	377	86	0	57	1.517
77	Hector Rebottaro	Argentina	187	380	169	111	172	292	70	25	95	1.501
78	Diego Pokorski	Argentina	153	398	139	144	175	374	20	0	76	1.479
79	Hunor-Istvan Daday	Romania	160	396	140	144	166	344	40	0	87	1.477
80	Luka Pavicic	Croatia	187	348	156	133	180	374	60	0	31	1.469
81	Fernando López Gregorio	Argentina	144	374	192	144	154	256	70	0	113	1.447
82	Jouni Sarkijarvi	Finland	143	326	104	144	175	332	78	0	137	1.439
83	Marko Obradovic	Serbia	123	350	161	133	185	325	70	0	74	1.421
84	Andrei-Alexandru Nicusan	Romania	160	334	167	144	150	288	60	0	102	1.405
85	Juha Hyvonen	Finland	123	392	188	144	129	295	70	0	57	1.398
86	Anton Titov	Bulgaria	160	384	125	111	174	328	20	0	86	1.388
87	Silvano Monastero	Italy	133	424	159	133	162	194	50	0	84	1.339
88	Marco Gaion	Italy	127	277	104	133	150	295	50	0	99	1.235
89	Zoran Radisavljevic	Serbia	108	371	141	111	165	212	50	0	57	1.215
90	Jaanus Laidna	Estonia	107	304	61	111	165	259	60	0	82	1.149
91	Justo Enrique Garcia Manyari	Peru	144	265	98	133	103	234	78	0	29	1.084
92	Aurelio Gonzalo Chávez Zavalaga	Peru	144	308	44	133	139	247	40	0	0	1.055
93	Mikhail Kuznetsov	Russia	60	359	93	111	97	126	40	0	57	943
94	Daniel Almirg Yalta Macedo	Peru	92	206	61	133	127	86	40	0	0	745
95	Ivan Roberth Rojas Marticorona	Peru	0	97	0	67	31	0	30	0	31	256